

UF515AC
Concealed Type Urinal Flusher

Spec. & Features

- ◆ Infrared Sensor For Automatic Operation
- ◆ Chrome Plated Brass Casting
- ◆ Power Source: AC110V or AC220V
- ◆ Infrared Sensor Range Adjustable :30cm to 70cm
- ◆ Flush Time Adjustment Setting : 2.4.6.8.10.12.14.16Sec
- ◆ 3 Second Arming Delay
- ◆ 1/2" Control Stop Valve
- ◆ Operating Water Pressure : 15 to 100 PSI
- ◆ Outline Dimension : 120mm*120mm
- ◆ Easy to Install and Maintain
- ◆ Thin design, thickness of the wall can be installed 10 cm above
- ◆ Solenoid valve is designed to prevent clogging.
- ◆ Quiet operation No Water Hammer
- ◆ Mechanically operates over 500,000 flushes
- ◆ Warranty : 1 year

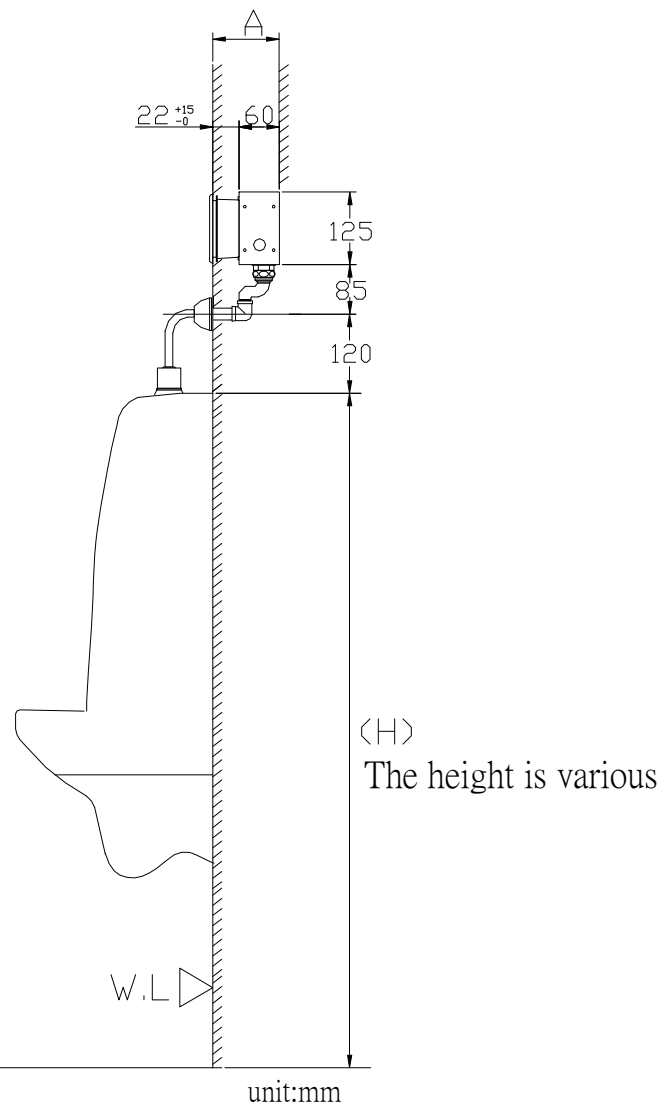
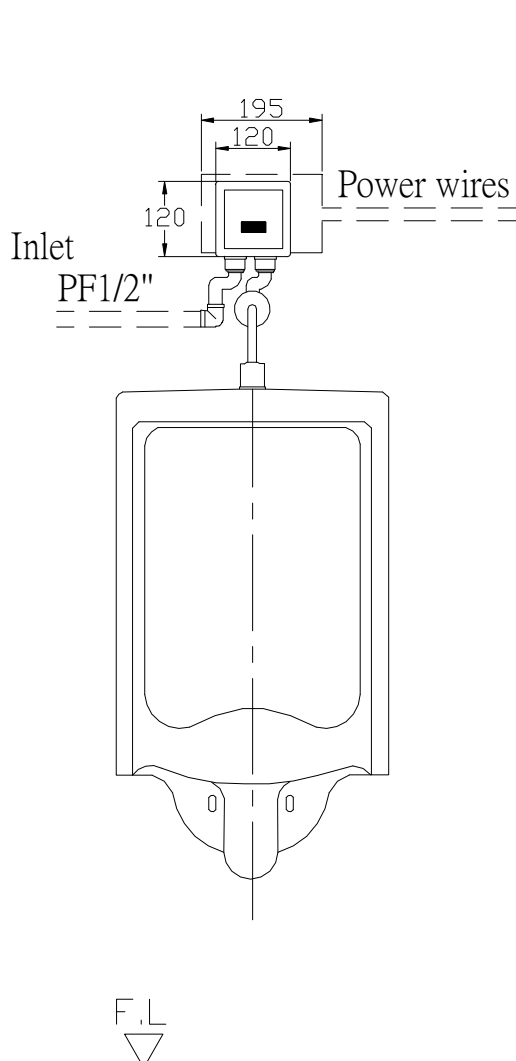

UF515DC
Concealed Type Urinal Flusher

Spec. & Features



- ◆ Infrared Sensor For Automatic Operation
- ◆ Chrome Plated Brass Casting
- ◆ Power Source: Size AA Alkaline Battery * 4pcs
- ◆ Infrared Sensor Range Adjustable :30cm to 70cm
- ◆ Flush Time Adjustment Setting : 2.4.6.8.10.12.14.16Sec
- ◆ 3 Second Arming Delay
- ◆ 1/2" Control Stop Valve
- ◆ Operating Water Pressure : 15 to 100 PSI
- ◆ Outline Dimension : 120mm*120mm
- ◆ Easy to Install and Maintain
- ◆ Thin design, thickness of the wall can be installed 10 cm above
- ◆ Solenoid valve is designed to prevent clogging.
- ◆ Quiet operation No Water Hammer
- ◆ Mechanically operates over 500,000 flushes
- ◆ Warranty : 1 year

